

MEETING POINTS *COURTYARD*

- TOUR 1
- TOUR 2
- TOUR 3
- TOUR 4
- TOUR 5

DATES TIMES

20.07.	18.45 Uhr // 6.45 pm
20.07.	19.15 Uhr // 7.15 pm
22.07.	14 Uhr // 2 pm
22.07.	17 Uhr // 5 pm

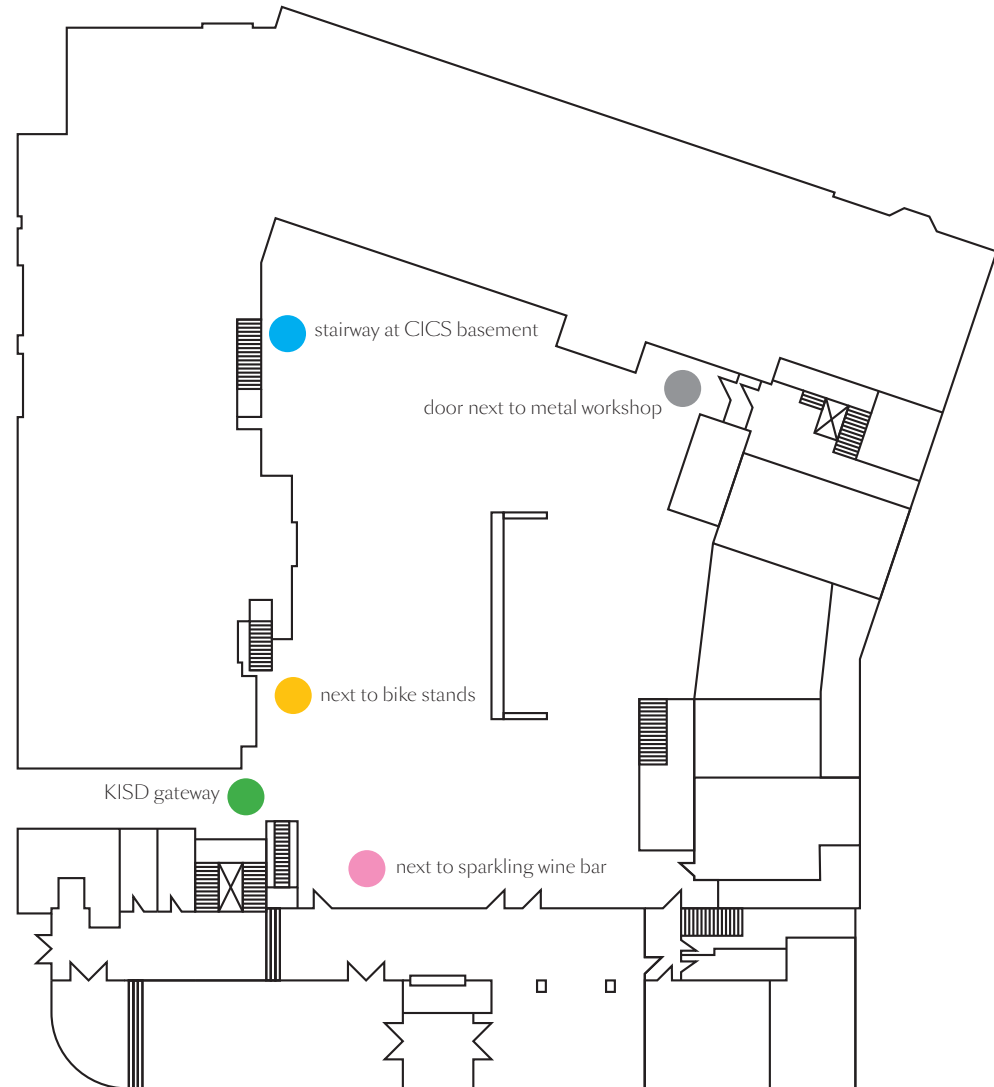

TOUR 1

BASEMENT

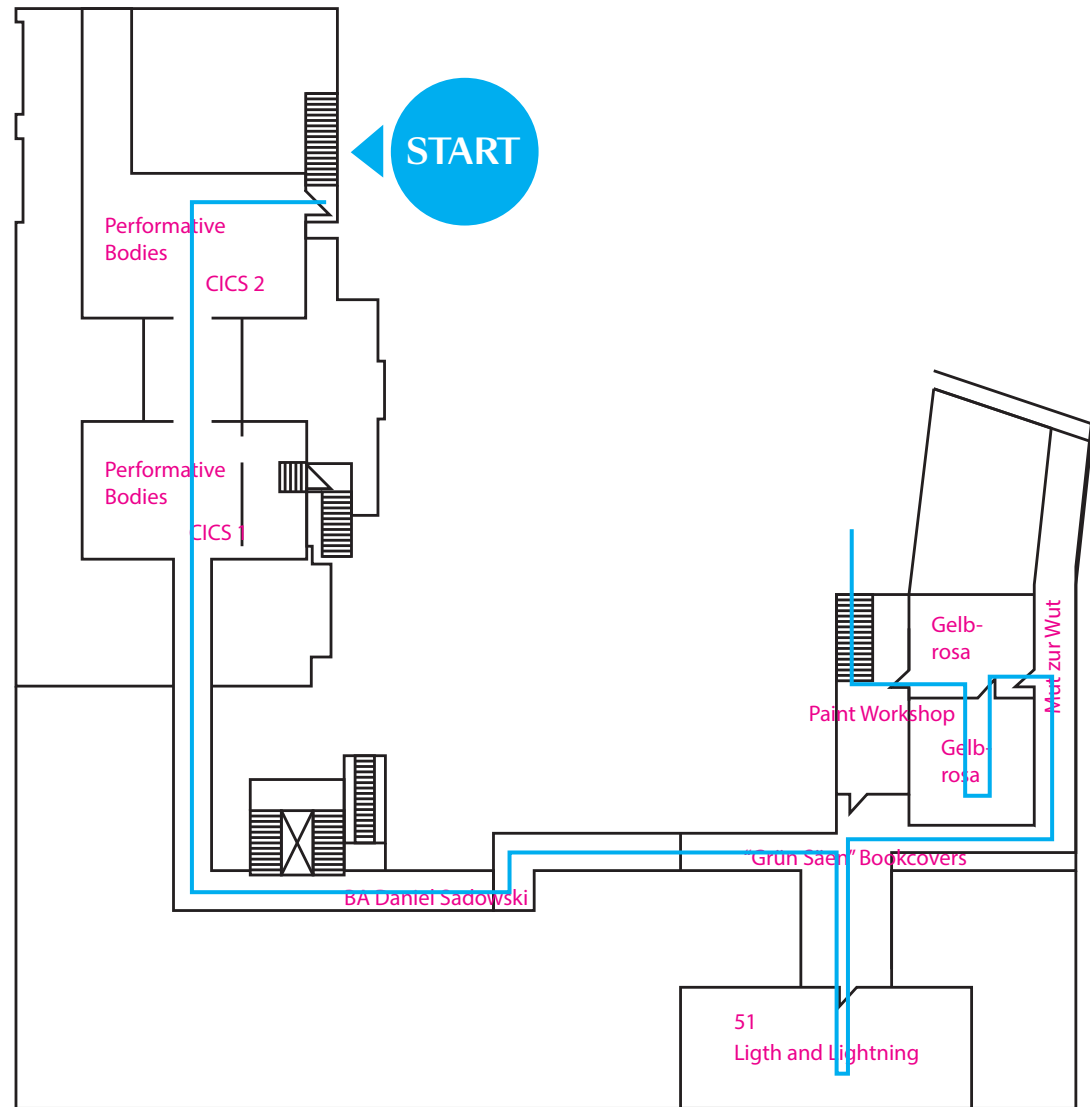

TOUR 1

GROUND FLOOR

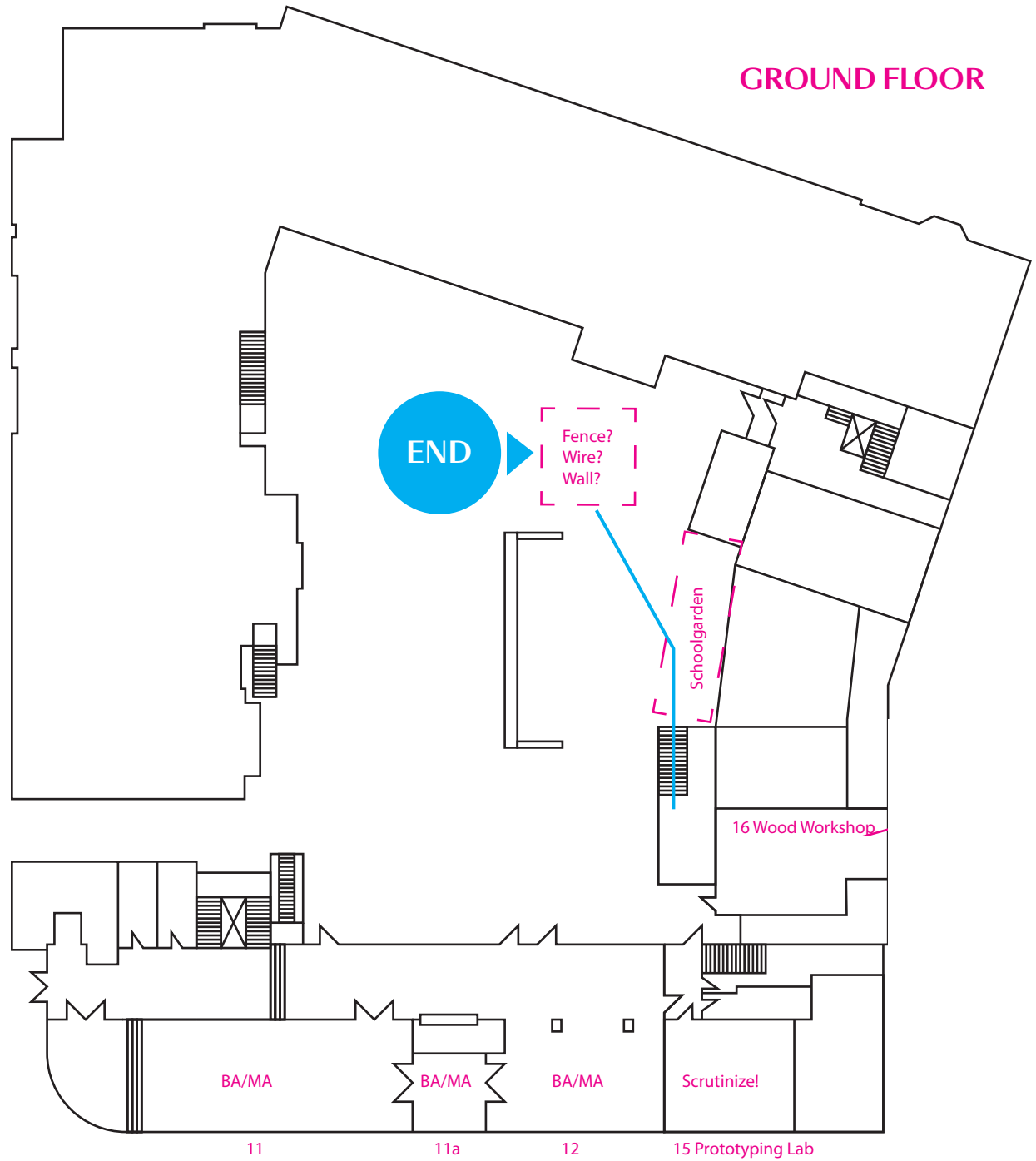

TOUR 2

GROUND FLOOR

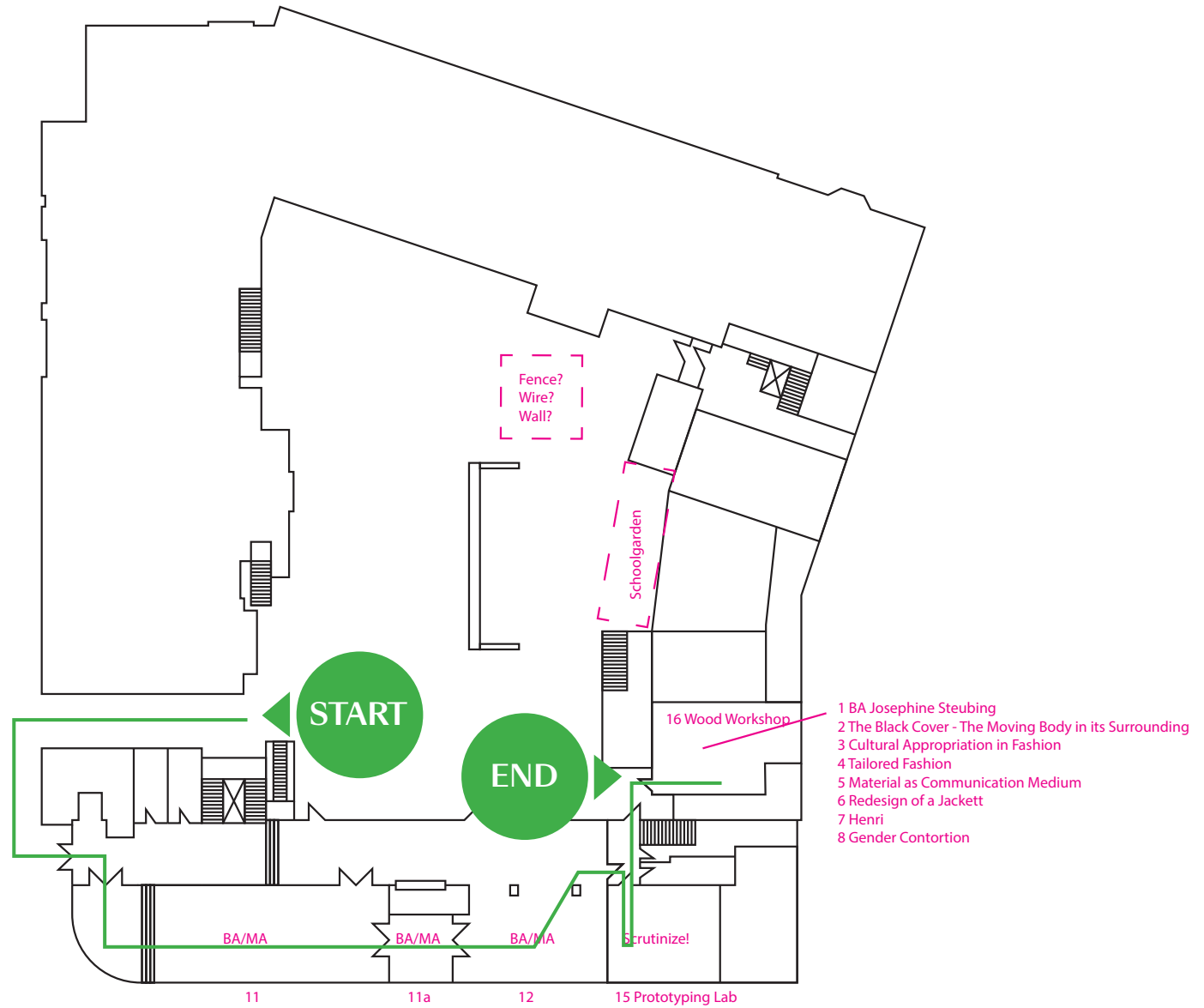

TOUR 3

1. FLOOR

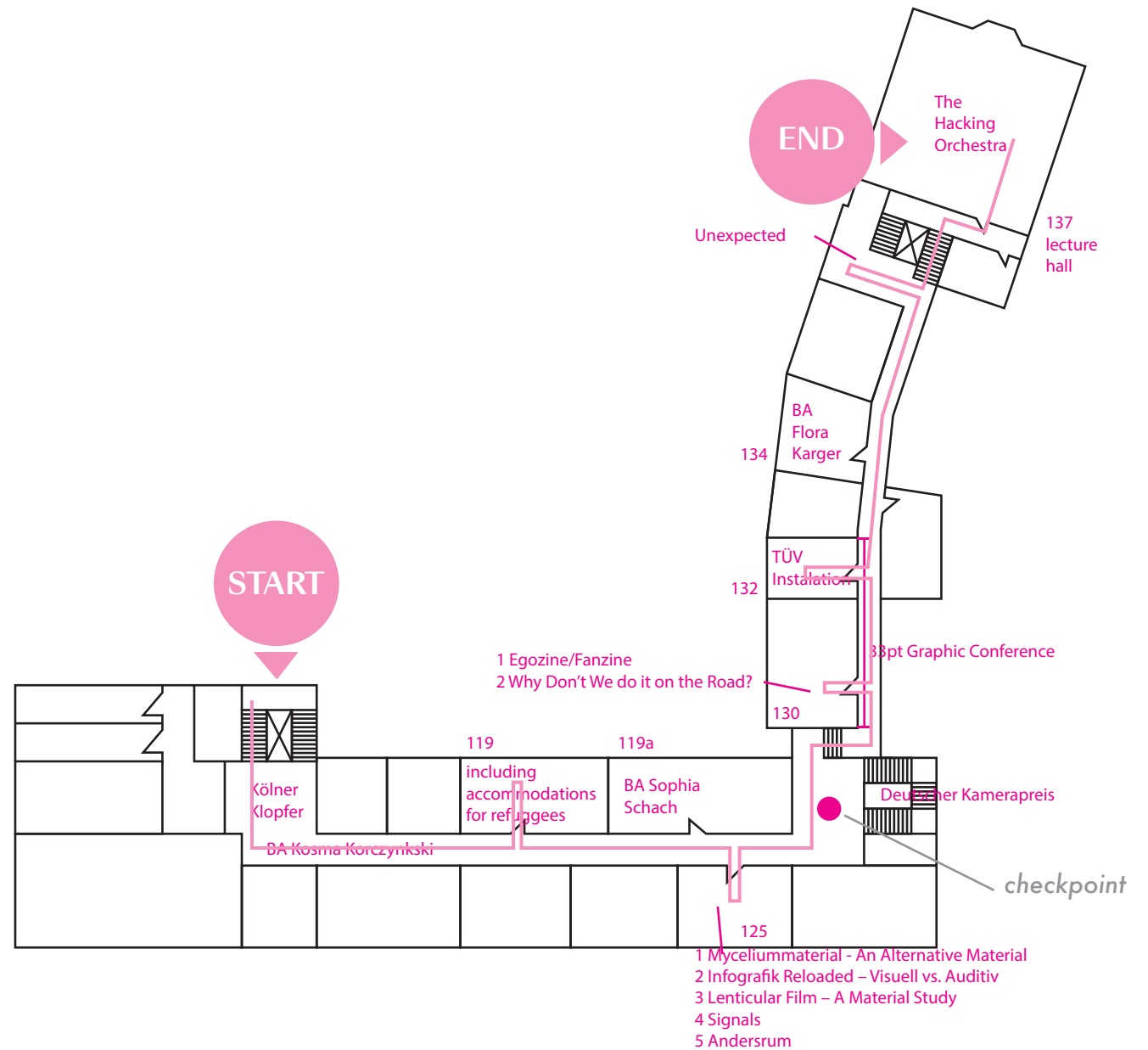

TOUR 4

2. FLOOR

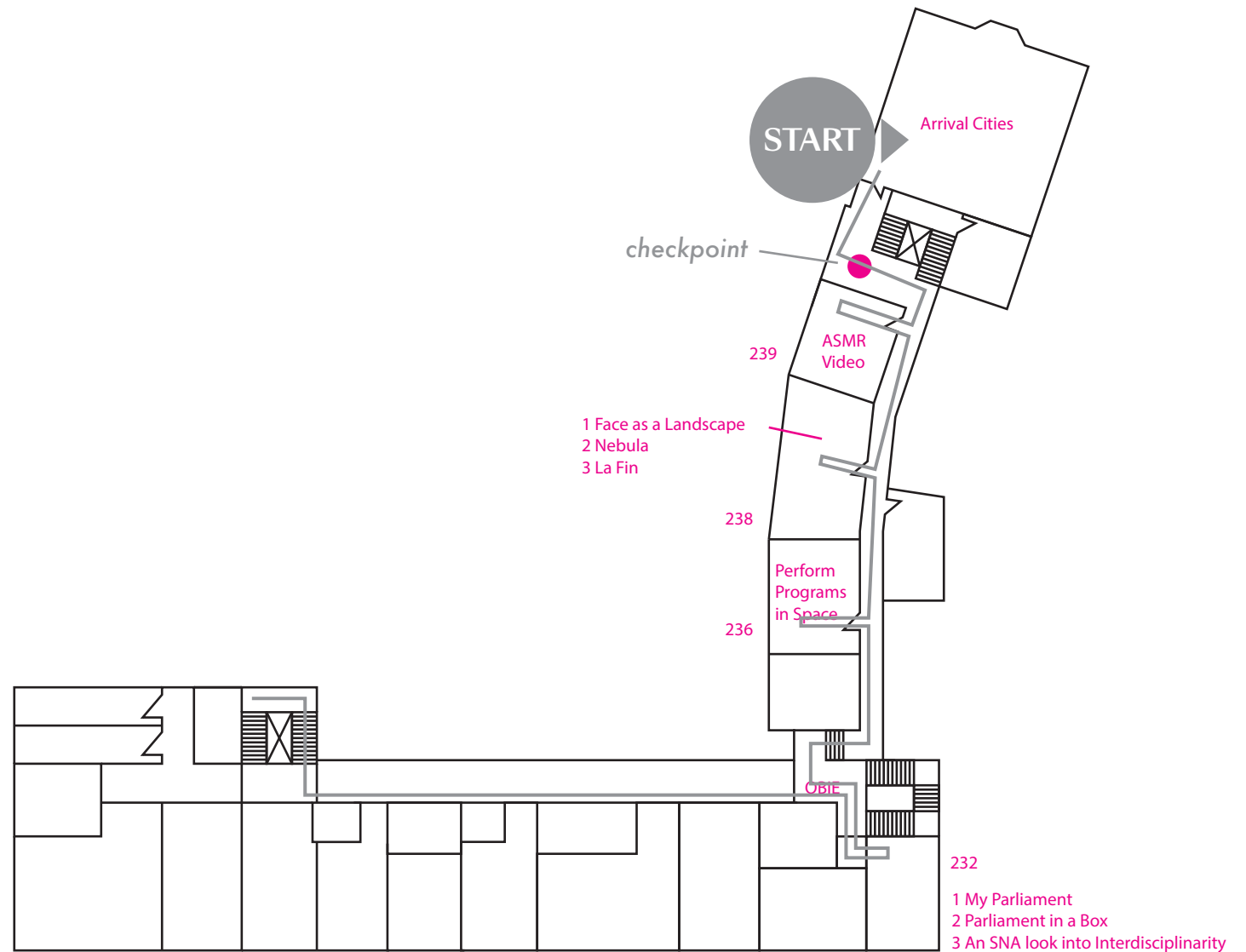

TOUR 4

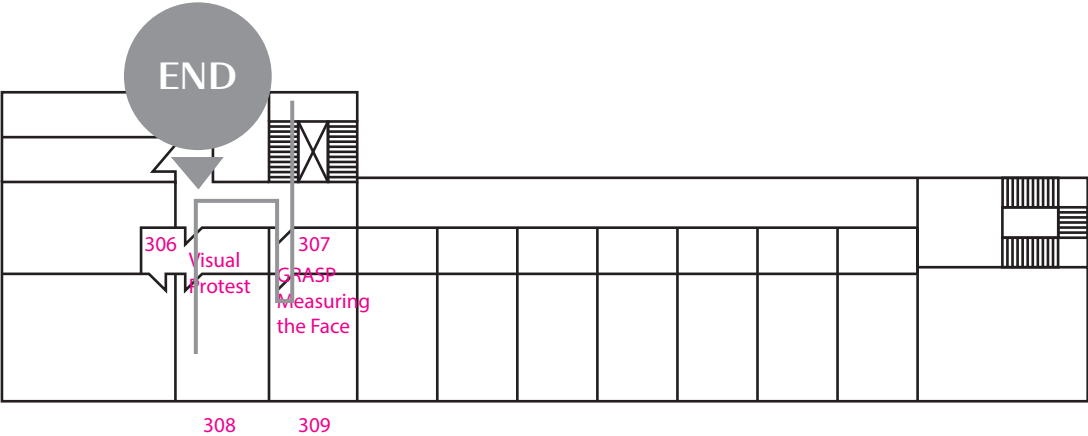

TOUR 5

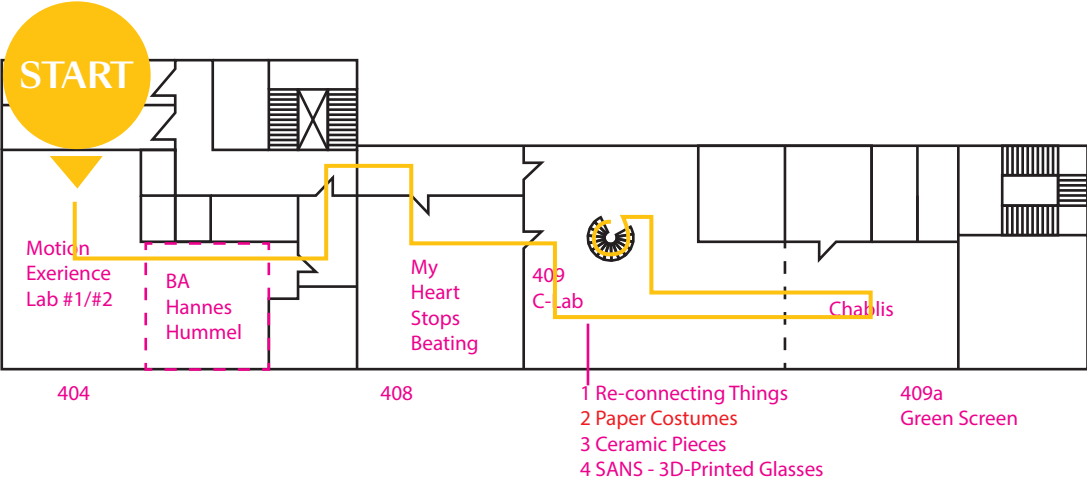

TOUR 5

